



**AW-AS200-2 Aspirating Smoke Detection System 2 Pipe  
Installation and Operation Manual**



## TABLE OF CONTENTS

TABLE OF CONTENTS .....	2
1 Product overview .....	3
2 System composition .....	3
3 System features .....	4
4 Product diagram .....	5
4.1 Appearance .....	5
4.2 Interface definition .....	6
4.3 Wiring .....	6
4.4 Touch screen operation .....	9
5 Installation .....	21
5.1 Basic size .....	21
5.2 Installation methods .....	22
5.3 Sampling pipe network installation .....	22
6 Maintenance .....	24
6.1 General provisions .....	24
6.2 Maintenance requirements .....	24
7 Faults and handling methods .....	25
8 Technical parameters .....	27



## 1 Product Overview

AW-AS200 aspirating smoke detection system adopts laser cavity detection technology, which can detect the fine smoke particles released in the early stage of material combustion. When the substance burns, the number of smoke particles in the air increases sharply. The pre-detection detection panel samples the air sample to the detection core, and uses the principle of "shading rate" to accurately detect the number of smoke particles in the air to reflect the change trend of fire smoke. When the shading rate reaches the set threshold, the pre-prediction will send out an alarm and notify the firefighters on duty in time to win more time for people to deal with fire hazards. Pre-prediction series detectors have a wide range of applications and are suitable for the following occasions:

**Tall spaces:** airports, rail transit, stadiums, warehousing and logistics, etc.

**Narrow space:** communication room cabinet, power system equipment interior, Internet data center, etc.

**Clean places:** electronics, pharmaceuticals, large hospitals, financial institutions, key laboratories, etc.

**Harsh places:** thermal power plants, cable trenches, paper mills, mines and traffic tunnels, etc.

**Important places:** high-rise buildings, high-end homes, libraries, archives, museums, etc.

## 2 System Composition

AW-AS200 aspirating smoke detection system is mainly composed of detectors, sampling pipe network and background monitoring software, as shown in the figure below:

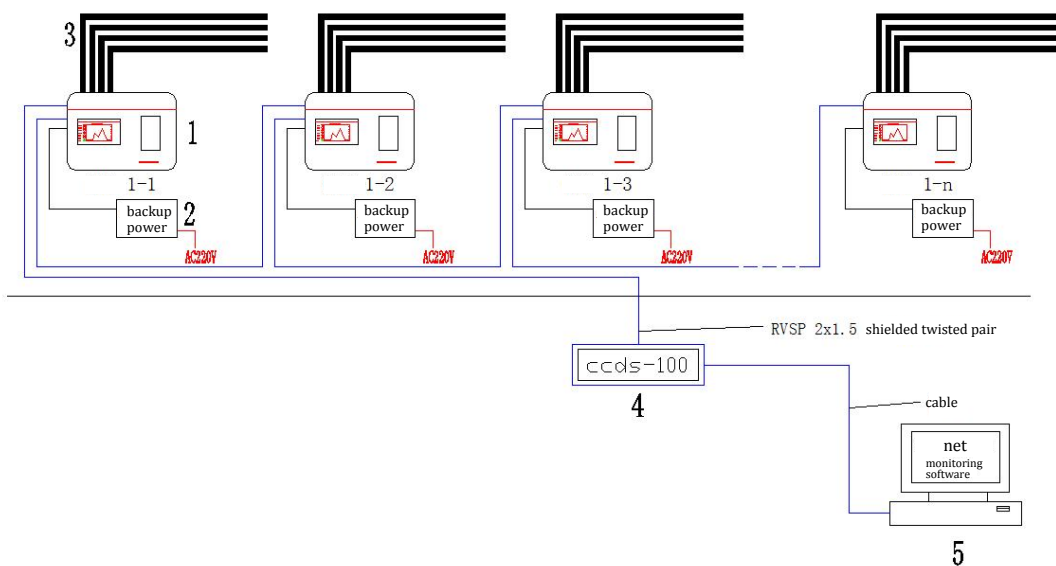

The corresponding components and functions in the figure are as follows:

No.	Device	Function
1	Aspirating smoke detector	Actively sample the air, analyze and alarm, and realize the communication between the panel and the panel, and between the panel and the background.
2	Specific power supply	Power supply for the detector

4	Gateway	Networking of multiple detection panels, used when communicating with the monitoring computer
5	Monitoring computer	Realize the information collection and summary of multiple sampling panels, realize remote monitoring and control, and provide humanized human-computer interaction pages.
3	Sampling pipe network	Main channel for air sample transport

### 3 System Features

- **Sensitive:** The detection is extremely sensitive and can distinguish particles as small as 2 nanometers, detecting early fire hazards very early.
- **Accurate, no false alarms:** Adopting the cloud chamber detection principle, it is extremely accurate in monitoring charged smoke particles and does not falsely report particles that are not generated by smoke, especially ordinary dust.
- **Low maintenance:** Avoid adding consumables like water or expensive filters. This system has a built-in high-efficiency compression pump, which can realize self-cleaning function.
- **Large detection area:** The theoretical detection area of each single-tube detector can reach 500 square meters.
- **Visualization of smog content:** The display screen is used to display the smoke content waveform, allowing people to intuitively feel the current smoke situation and make timely adjustments.
- **Easy to operate:** Using a 5-inch touch screen, there is no need to press buttons for operation and settings, providing users with great convenience
- **Multi-level alarm function:** It is divided into five alarm stages, namely warning, early warning, patrol, fire alarm 1 and fire alarm 2. The parameter values of each stage can be set according to customer needs, making it convenient for users to adjust parameters on site.
- **Multiple quick settings:** Quick setting options for alarm sensitivity in four different scenarios are preset, namely clean environment, ordinary environment, complex environment and harsh environment, making it easy for on-site personnel to adjust.
- **Parameter custom function:** Can be run according to customer's customized parameters.
- **Self-learning function:** Periodically collect surrounding environmental conditions for automatic analysis, and automatically adjust appropriate parameters to facilitate customer use.
- **Special alarm input:** Through external signals, the microcontroller can execute the alarm parameters set by the customer.
- **Historical alarm query function:** Can save 30,000 historical alarms
- **Event record function:** Able to save on-site operation records for background query.
- **Black box function:** When the detector fails, it can keep recording all setting parameters and operating parameters at the last moment for customers to locate the event.



## AW-AS200-2 Aspirating Smoke Detection System 2 Pipe

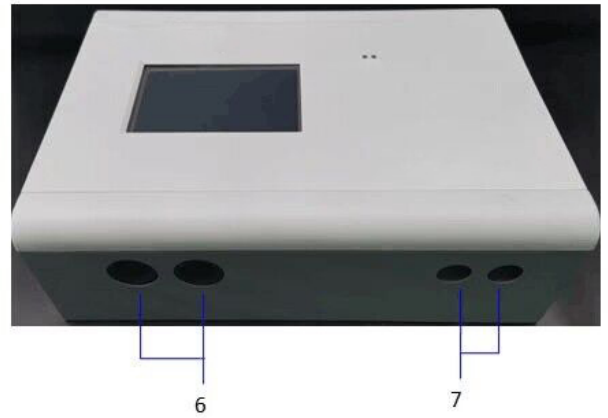
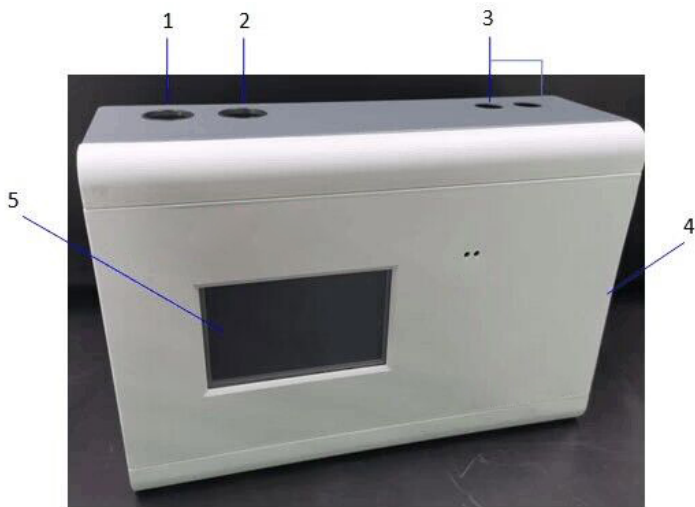

- (1) Suction channel 1
- (2) Suction channel 2
- (3) Upper cable entry and exit holes
- (4) Front door
- (5) Touch screen
- (6) Vent
- (7) Lower cable entry and exit holes

### 4.2 Interface definition

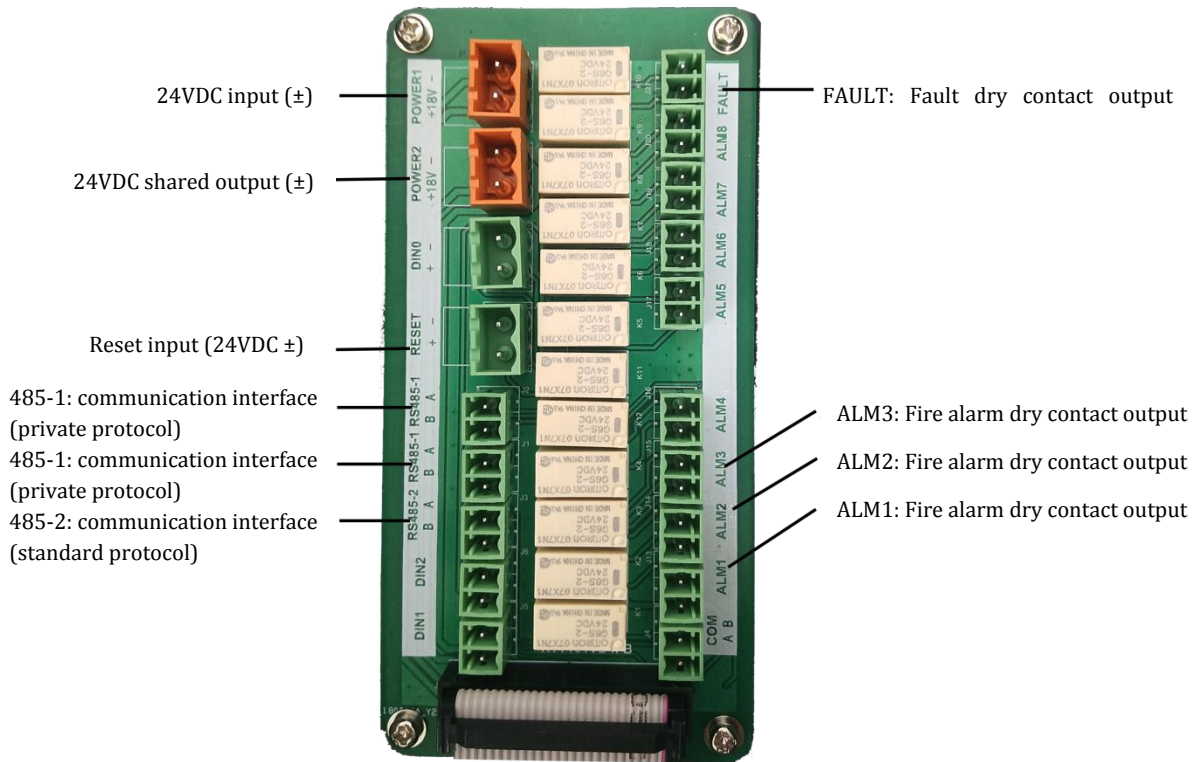

### 4.3 Wiring

No.	Connection method	Example
1	Connect to background software	Install an independent set of monitoring background software in the fire duty room to uniformly manage the operating status and data of all detectors
2	Connect to fire alarm panel	Through three input modules, the detector's warning, fire alarm and fault signals are fed back to the fire panel. Through an output module, the fire panel can remotely reset the detector.
3	Connect to strobe sounder	External strobe sounder
4	Connect to third-party systems	Such as access to dynamic environment monitoring system, power management platform, Internet of Things platform

4.3.1 Connect to background software

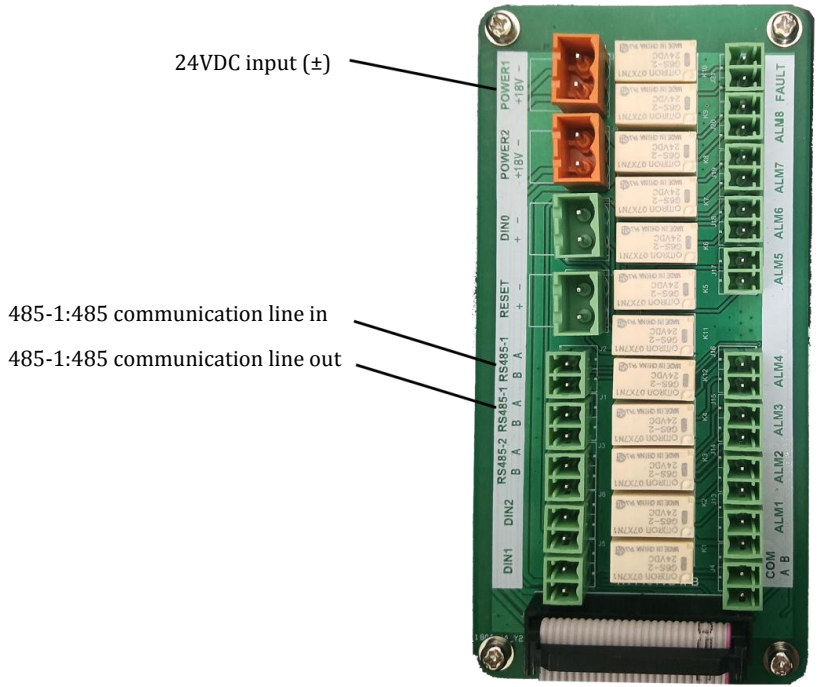

4.3.2 Connect to fire alarm panel

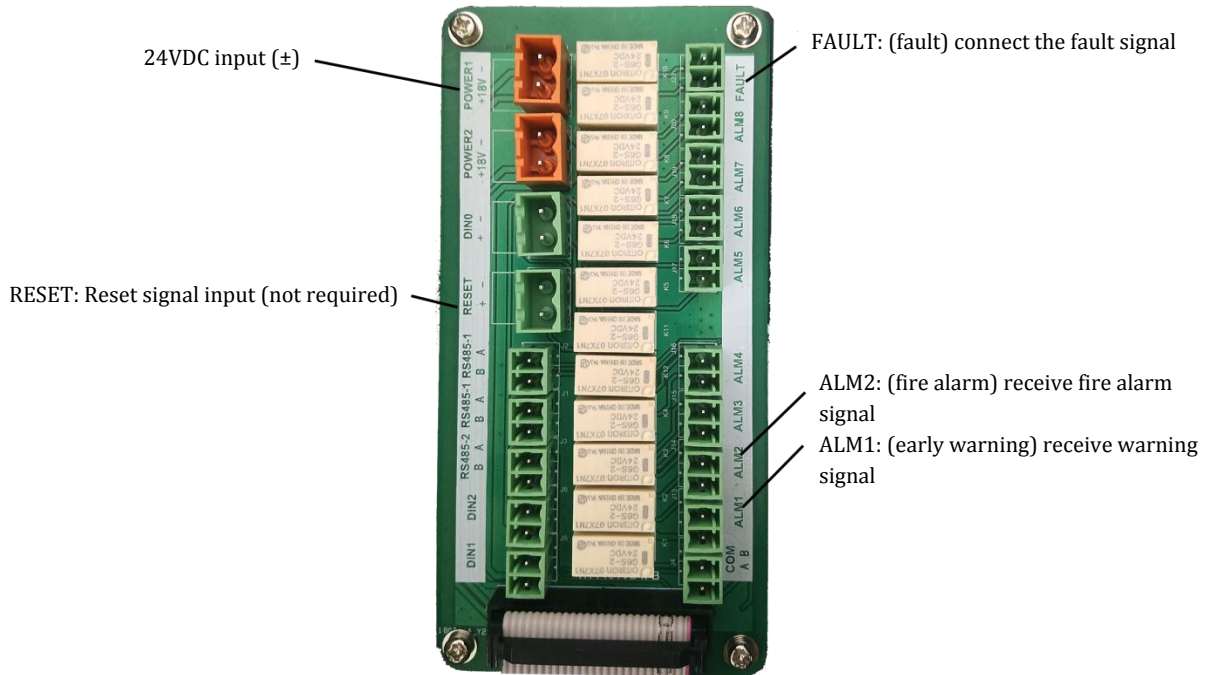

4.3.3 Connect to strobe sounder

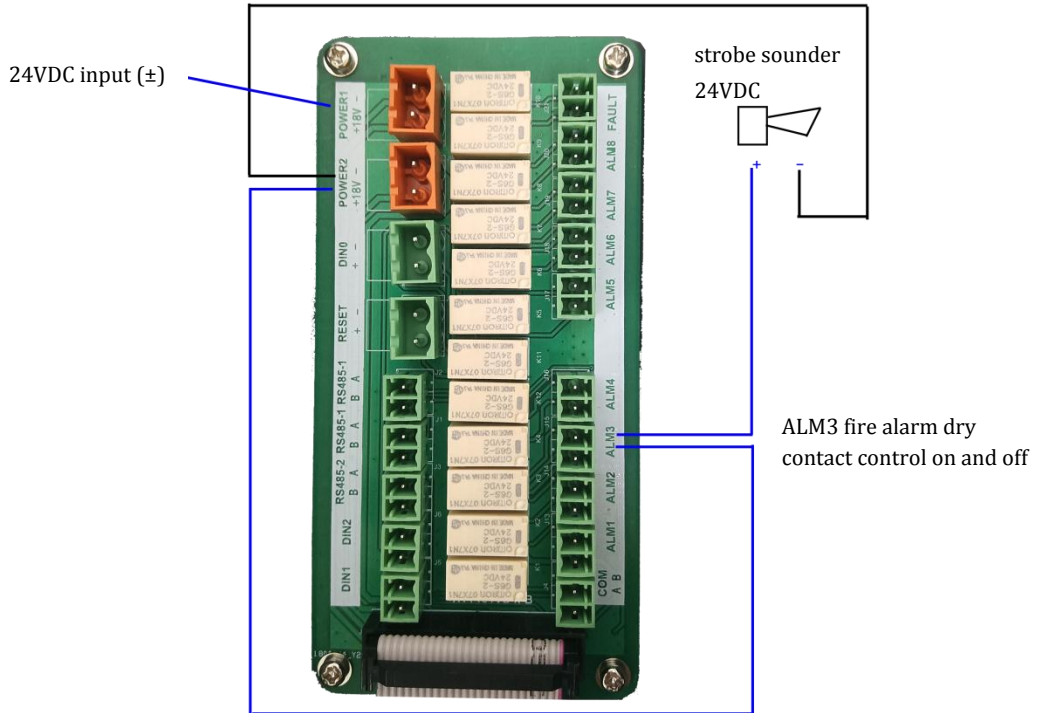

4.3.4 Connect to third-party systems

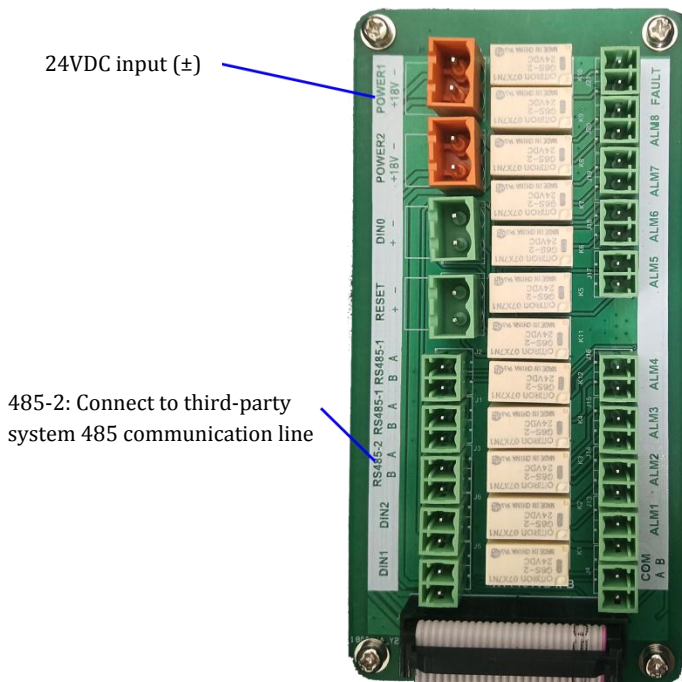

#### 4.4 Touch screen operation

##### 4.4.1 System operation main page

After the detector is started, the system operation main page will be entered, as shown in the figure below:

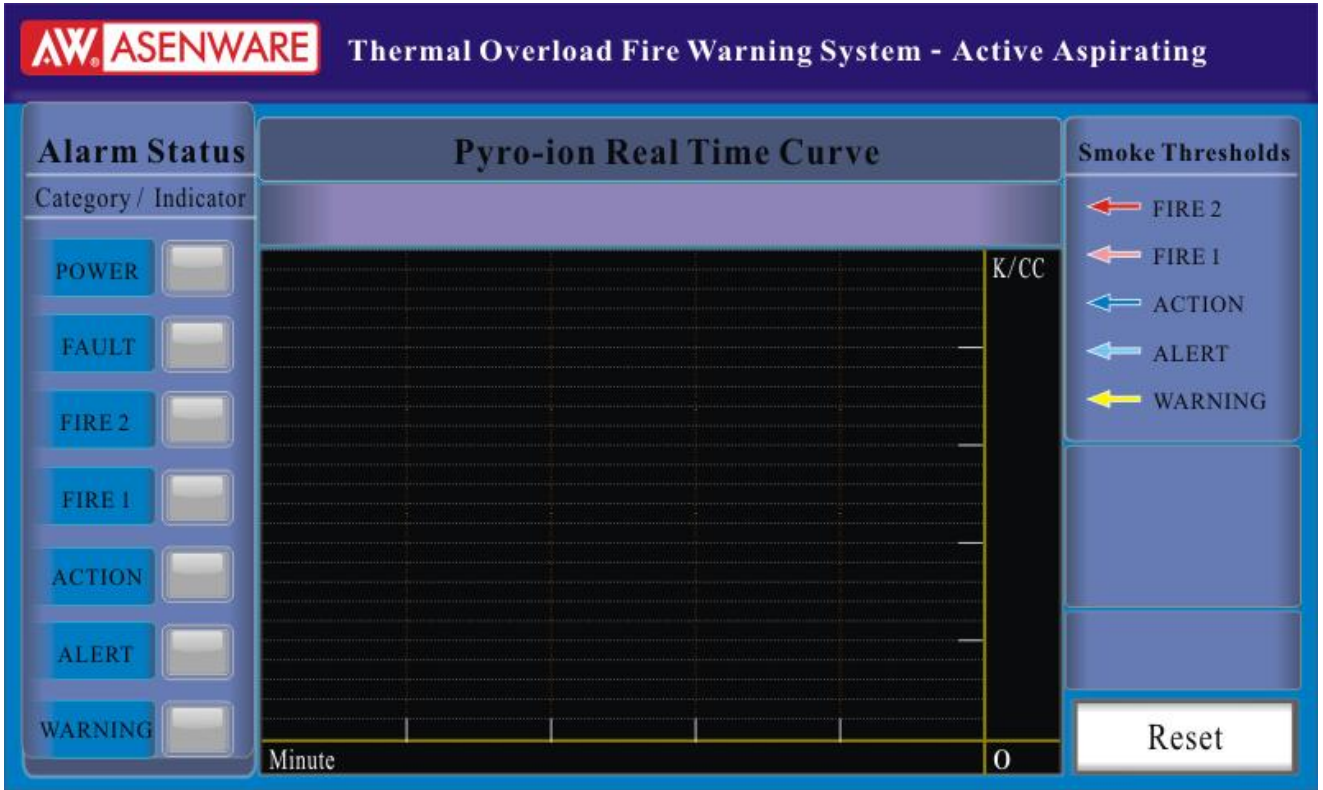

##### 4.4.2 "Settings" page

Touch the middle area of the screen to enter the main settings page. As shown below:

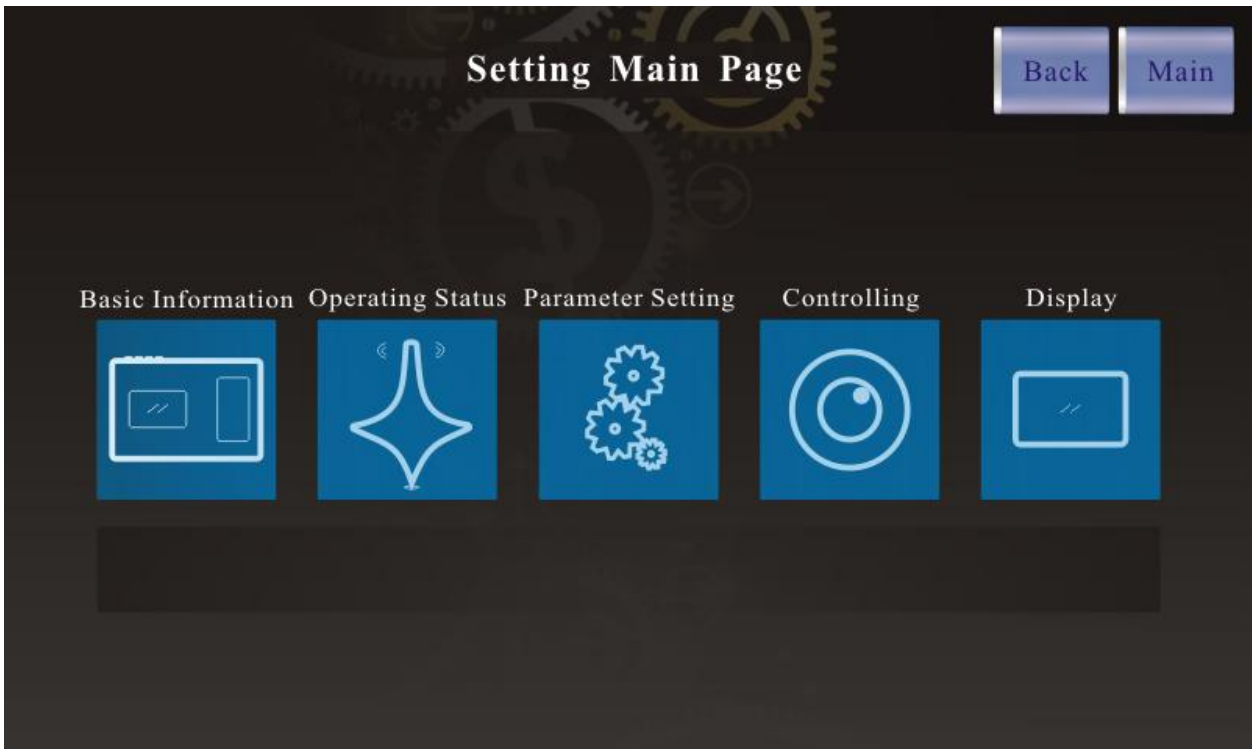

4.4.3 "Basic information" page

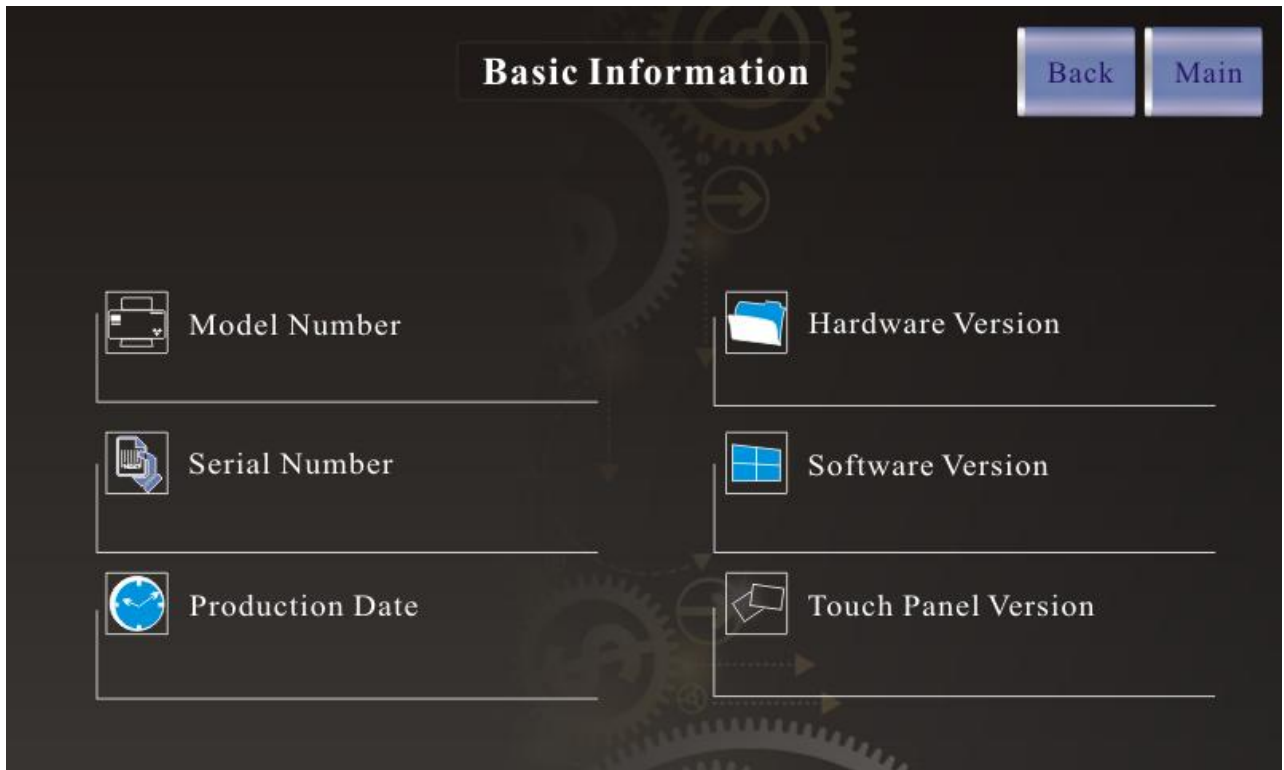

4.4.4 "Operating Status" page

A) "Operating Status" page:

It can display the real-time working voltage, ambient temperature and humidity and the current real-time value of each channel, as shown in the following figure:

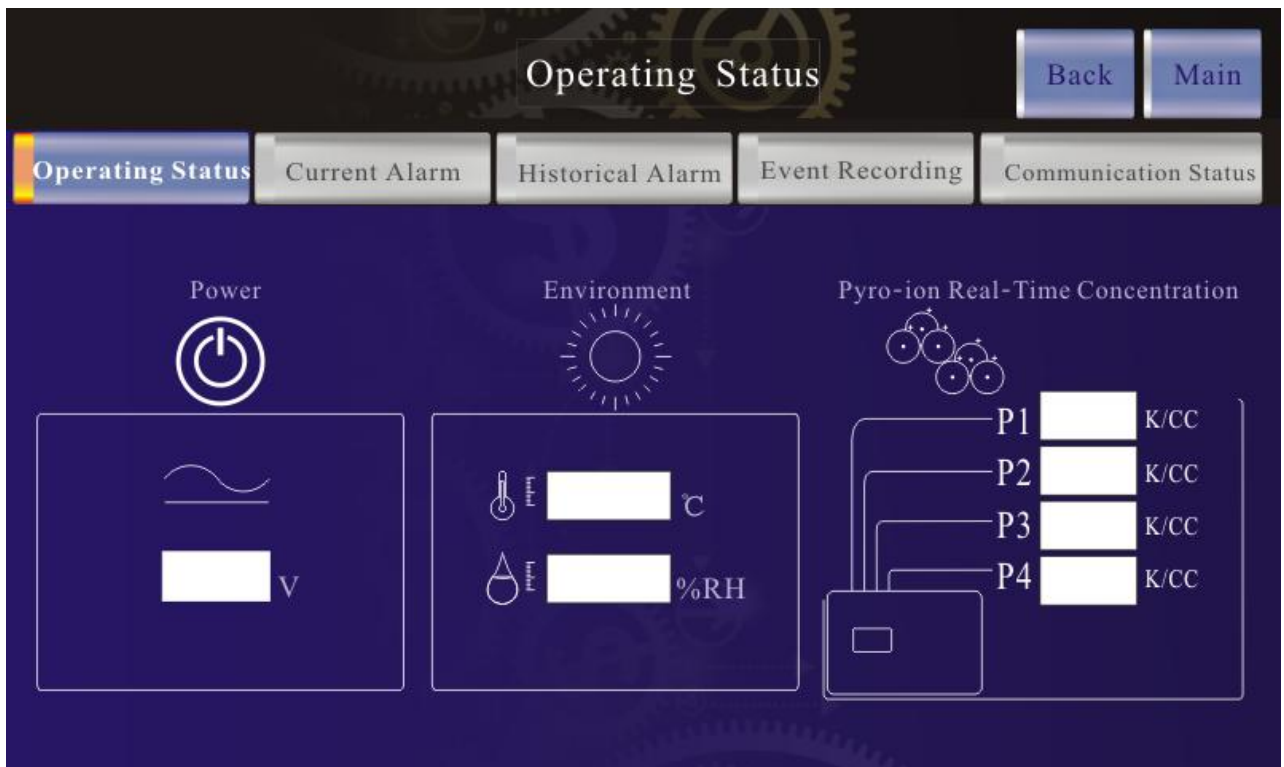

**B) "Current Alarm" page:**

Switch to the "Current Alarm" tab to view the unreset alarm or fault event records that occurred during the operation of the detector. From the records, you can see the time and type of the event, as shown in the following figure:



**C) "Historical Alarm" page:**

Switch to the "Historical Alarm" tab to view all alarm or fault event records that have occurred on the machine in the past.

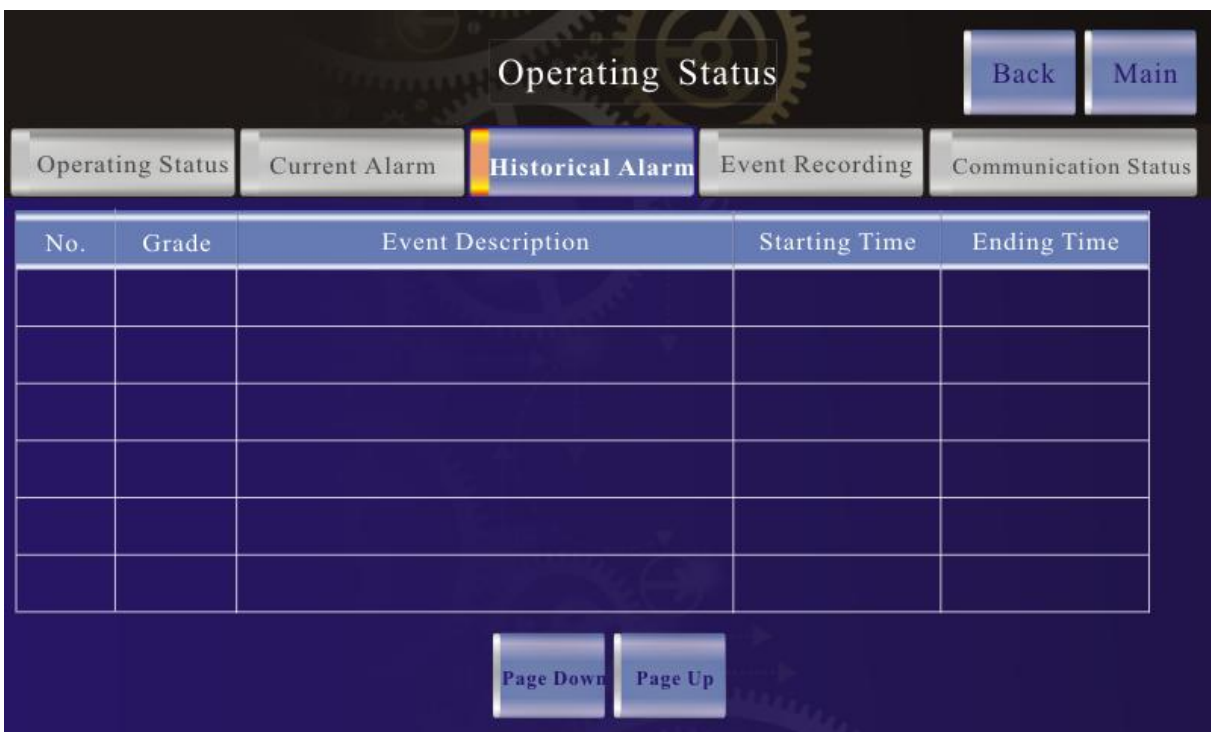

**D) "Event Recording" page**

Switch to the "Event Recording" tab to view records of operations such as resetting the detector and modifying parameters.



**E) "Communication Status" page**

You can view the detector's 485 communication address, installation location and communication status (stand-alone operation/background operation).

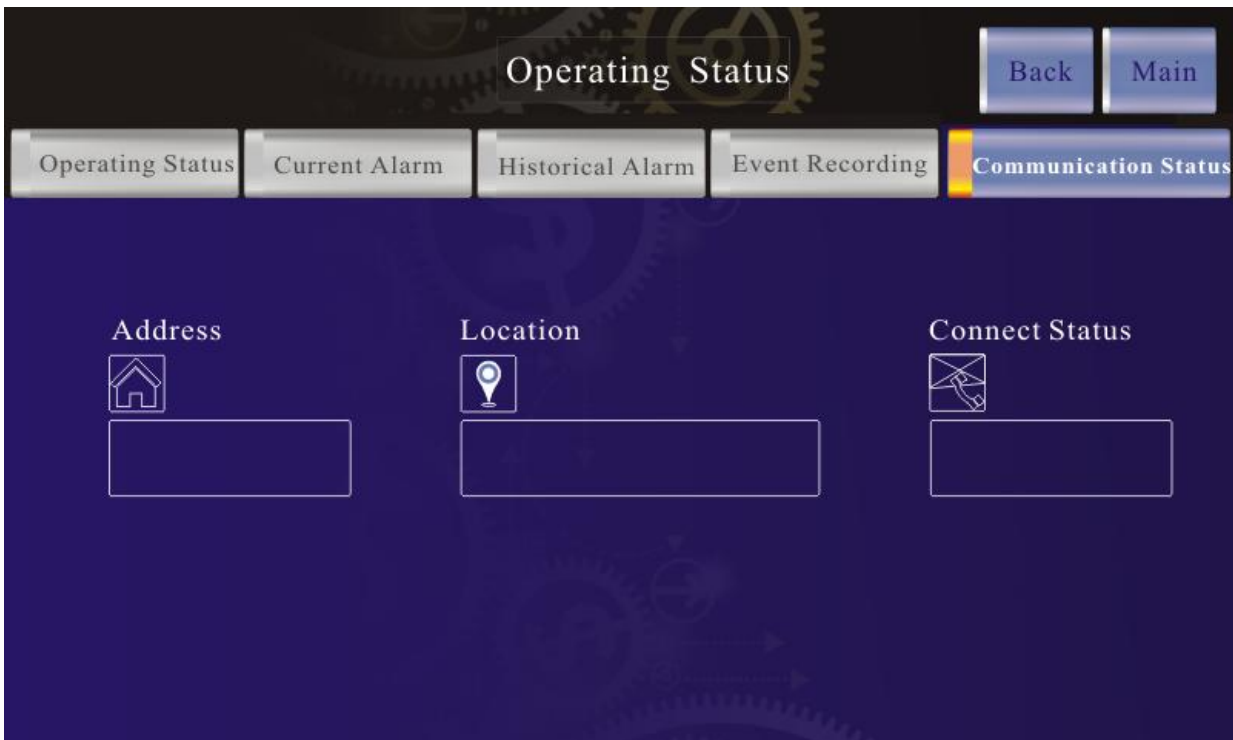

Click the "Back" button in the upper right corner to return to the main page of the system menu.



4.4.5 "Parameter Settings" page

On the main page of the system menu, click the "Parameter Settings" button (password verification required) to enter the parameter setting page: This page displays basic settings, user-defined settings, scene application settings, address and time settings and other information. As shown below:

a) "Basic Settings" page:

On this page, you can set the number of sampling tubes, application scenarios (sensitivity levels), opening and closing of air flow monitoring and sensitivity levels, and opening and closing of scene application functions.



**Protection area selection:** the number of sampling tube applications can be set (all checked by default and cannot be cancelled);

**Application scene setting:** You can choose the type of application scene. The sensitivity corresponding to different scenes is different. The sensitivity is getting higher and higher from "harsh environment → complex environment → ordinary environment → clean environment";

**Airflow monitoring settings:** You can choose whether to enable the airflow monitoring function. If enabled, the sensitivity of air flow monitoring can be selected, and the sensitivity will increase from "normal → sensitive → extremely sensitive";

**Scenario application function (not enabled by default):** In some places with "application false alarms", such as places with fuel forklifts, the scene application function can be enabled (this function requires an additional behavioral intelligent recognition system to be implemented). After enabling it, when the intelligent recognition system recognizes the behavior, it will send a signal to the detector, and the detector will automatically switch to the sensitivity of "Scene Application Settings". The alarm threshold can be set in the "Scenario Application Settings" tab.

b) "User Defined Settings" page

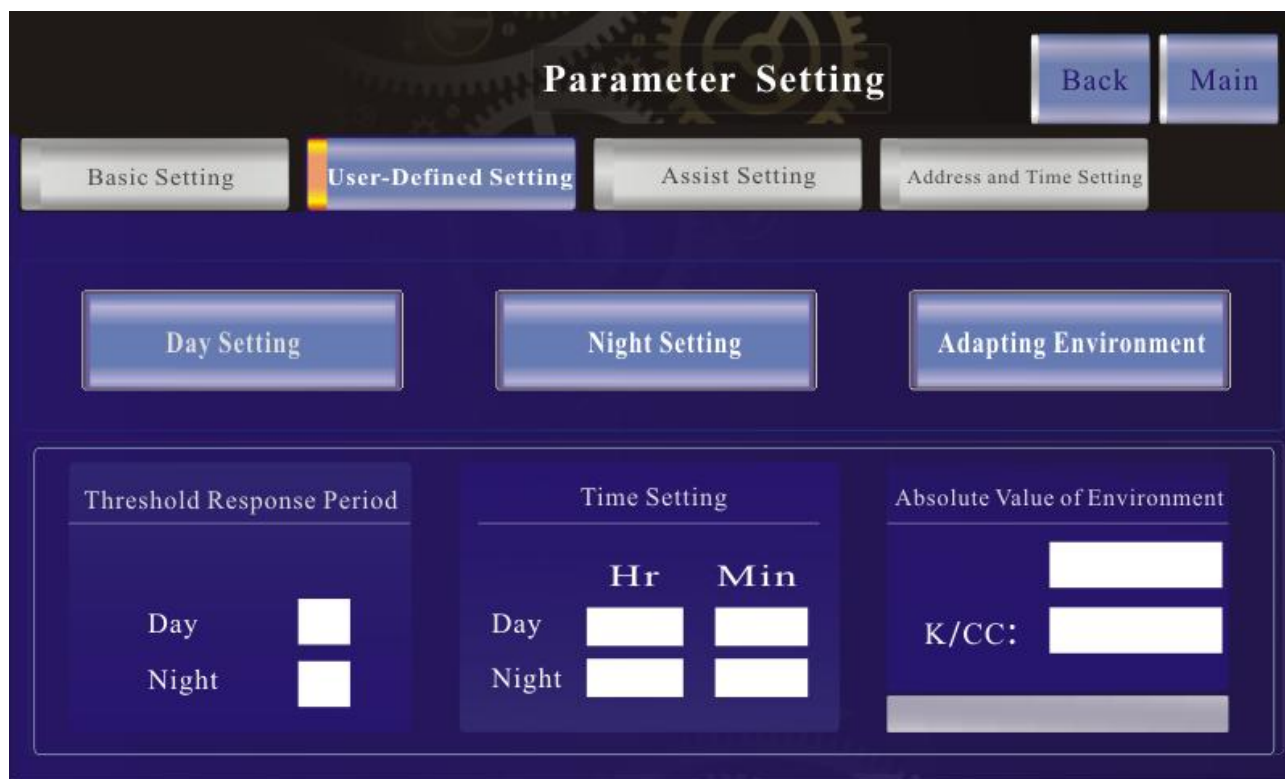

**Daytime setting:** Set the alarm threshold and delay time for daytime execution.

**Night setting:** Set the alarm threshold and delay time for night time execution.

**Adaptation to the environment:** When the detector needs to be recalibrated, select this function and enter the password to perform calibration.

**Threshold response period:** When both daytime and nighttime are checked, the daytime alarm threshold and delay time will be implemented during the daytime period, and the nighttime alarm threshold and delay time will be implemented during the nighttime period. When only day (or night) is checked, the alarm threshold and delay time of day (or night) will be executed 24 hours a day regardless of time period.

**Time period setting:** Set the start time and end time of day/night.

**Environmental absolute value reference:** displays the absolute concentration value of the current system.

① "Daytime setting" page:

This page allows you to set the alarm threshold for detector execution during the day, as follows:

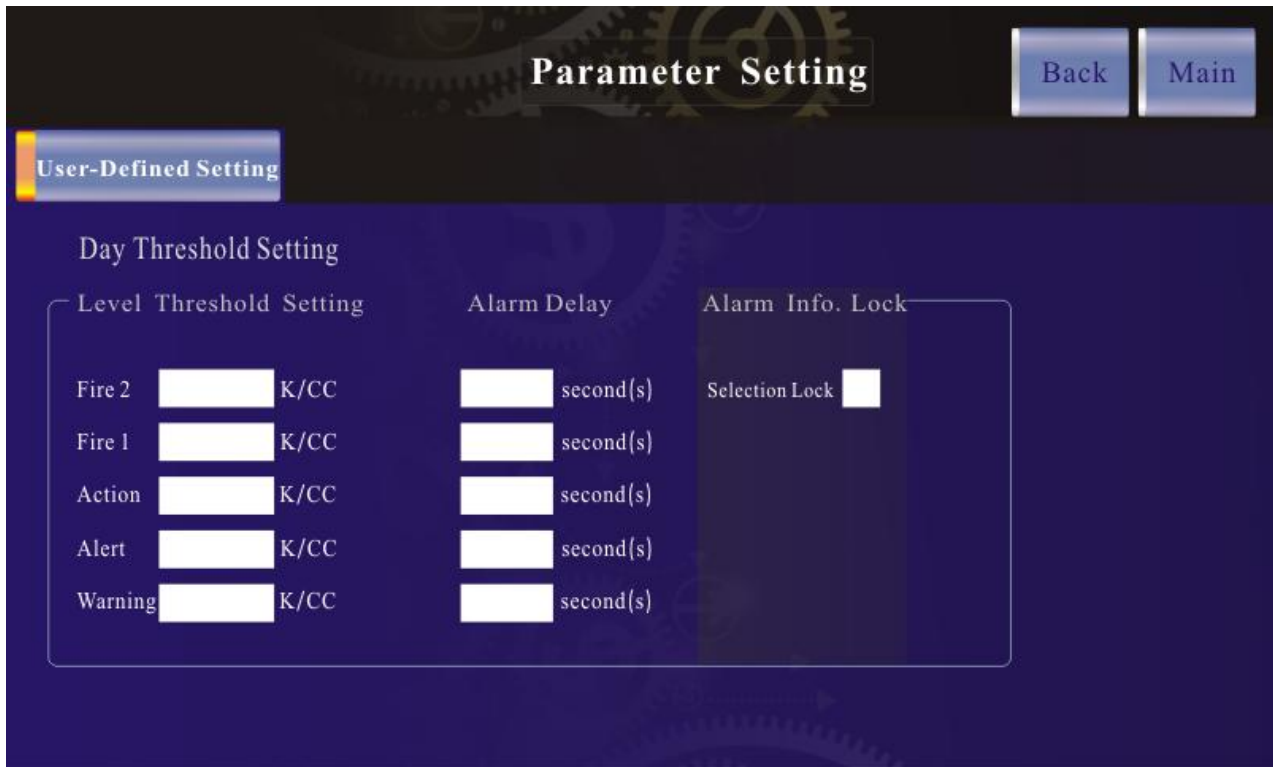

**Daytime threshold setting:** Set 5 levels of alarm thresholds and delay times

**Level:** There are 5 levels of alarm thresholds that can be set. From light to severe, they are warning → early warning → patrol → fire alarm 1 → fire alarm 2. The corresponding set values should be from small to large, that is, warning < early warning < patrol < Fire alarm 1 < Fire alarm 2.

**Alarm delay:** The detector's real-time concentration value needs to reach the set threshold of the current level and maintain the delay time corresponding to this level before an alarm of this level is triggered. For example, an alarm will be triggered only when the real-time concentration value reaches a and remains for t1. The delay time is accumulated from low to high. For example, the patrol level requires the detector's real-time concentration value to reach c and maintain t1+t2+t3 time before it will be triggered.

**Alarm information lock:** If checked, the detector needs to be manually reset after alarming before the detector can return to normal state. If unchecked, the detector will automatically reset as long as the concentration no longer meets the alarm conditions after the detector alarms.



② "Night setting" page:

This page allows you to set the alarm threshold for detector execution at night. Please refer to the daytime setting method for specific settings, as follows:

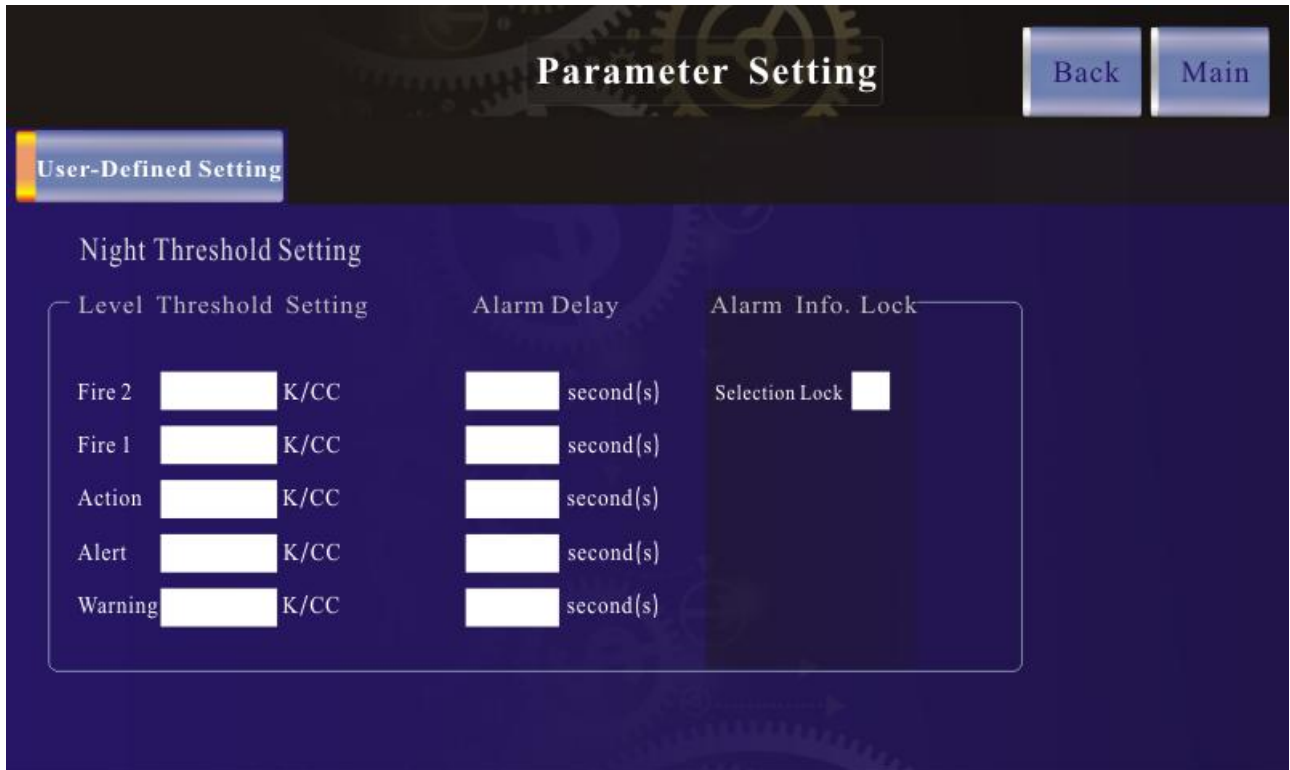

③ "Assist Settings" page

**Assist settings function:** Used in scenarios where behavioral actions cause false alarms from the detector, such as smoking, car exhaust, etc. It needs to be used with a behavioral intelligent recognition system. After enabling this function, when a behavior is recognized, the detector automatically switches to the alarm threshold of the scene application and remains independent for time T. If no behavior recognition signal is received before the end of T, the regular alarm thresholds for day/night will be resumed after the end of T.

When applying the scene function, you can enter this page to set the corresponding parameters, as follows:

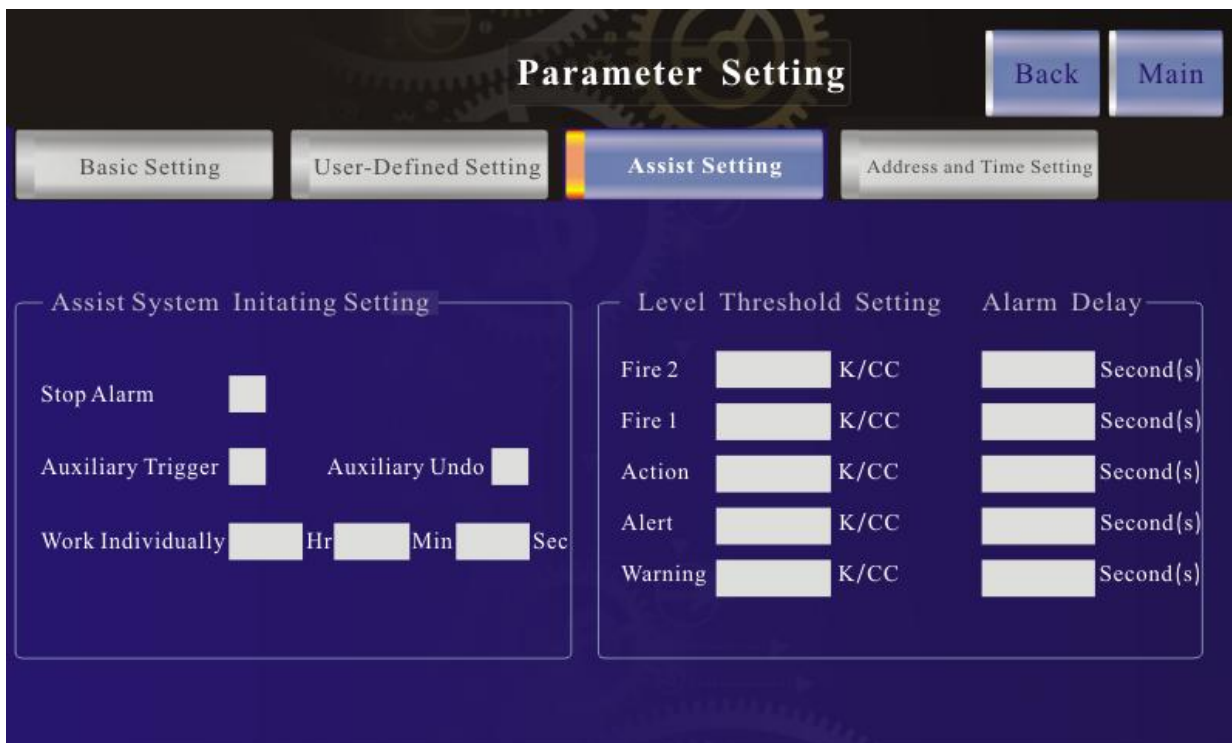

Scene assist system activation settings:

**Scene stop alarm:** whether to stop the alarm when receiving a trigger signal

If you check "√", when the trigger signal is received, the detector will not alarm even if the concentration exceeds the meter.

If you do not check "√", when the trigger signal is received, the threshold set by the scene application will be executed and the alarm will be issued normally.

**Auxiliary system trigger:** The external normally open signal is used as the trigger signal of the scene auxiliary system

**Auxiliary collaborative cancellation:** the external normally closed signal is used as the trigger signal of the scene auxiliary system

**Switch to independent work:** When triggering the scene application, keep the scene application setting threshold for time T.

**Level:** There are 5 fire alarm level settings, from light to heavy, they are warning → early warning → patrol → fire alarm 1 → fire alarm 2. The corresponding setting values should be from small to large.

**Alarm delay:** The alarm of this level will be triggered only when the detector reaches the current level concentration value and maintains the delay time corresponding to this level. The delay time is accumulated



from low to high.

④ "Address and Time Settings" page

Switch to the "Address and Time Setting" page on the parameter setting page to enter the address time setting page. On this page, you can set the detector's communication address, installation location, detector time and communication baud rate.

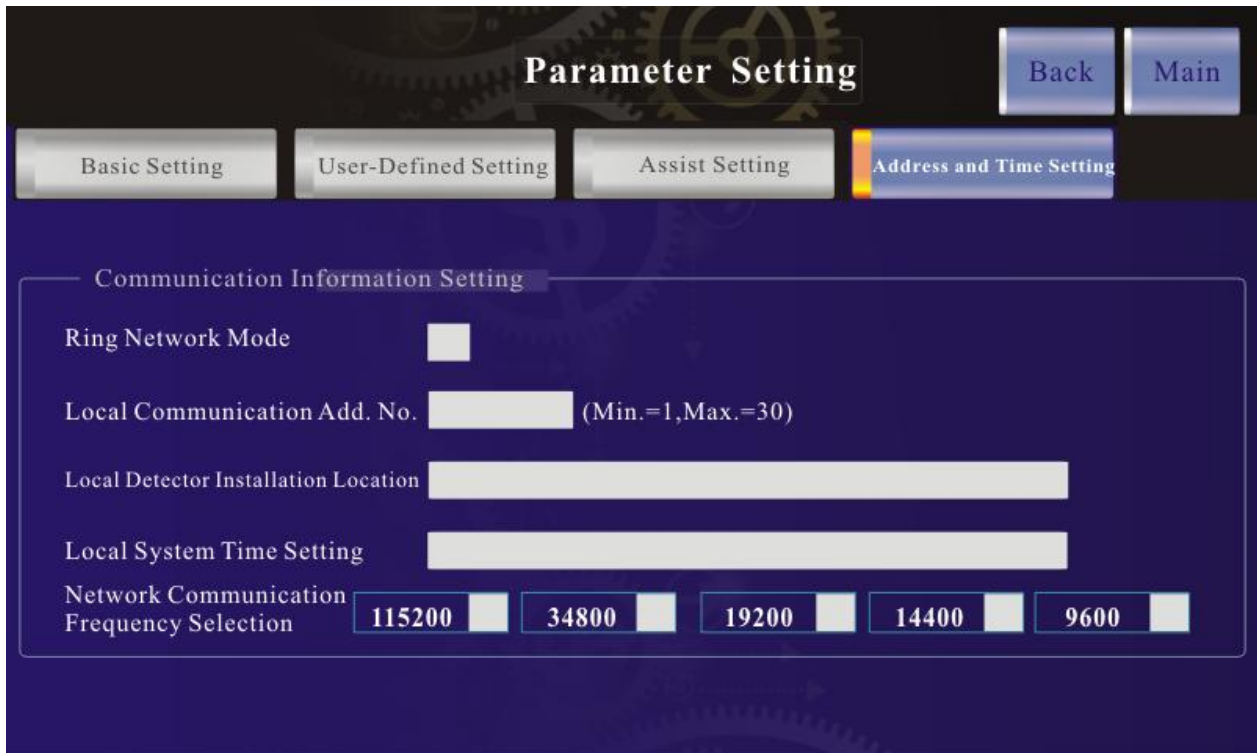

**Enable ring networking mode:** There are two types of networking: open loop and closed loop, which can be set according to actual applications.

**Communication address:** It is an RS485 address, with a maximum of no more than 30.

**Installation location:** The installation location of the detector can be defined, such as the xx computer room on the xx floor of the xx building.

**Time setting:** The detector running time can be set.

**Communication frequency:** that is, the baud rate of the detector for modbus communication.

### 4.4.6 "Controlling" page

On the main page of the system menu, click the "Controlling" button and enter the 6-digit password to enter the control page: On this page, you can perform application testing, password modification, factory reset, sampling capacity, alarm switch, clear records and other operations. As shown below:

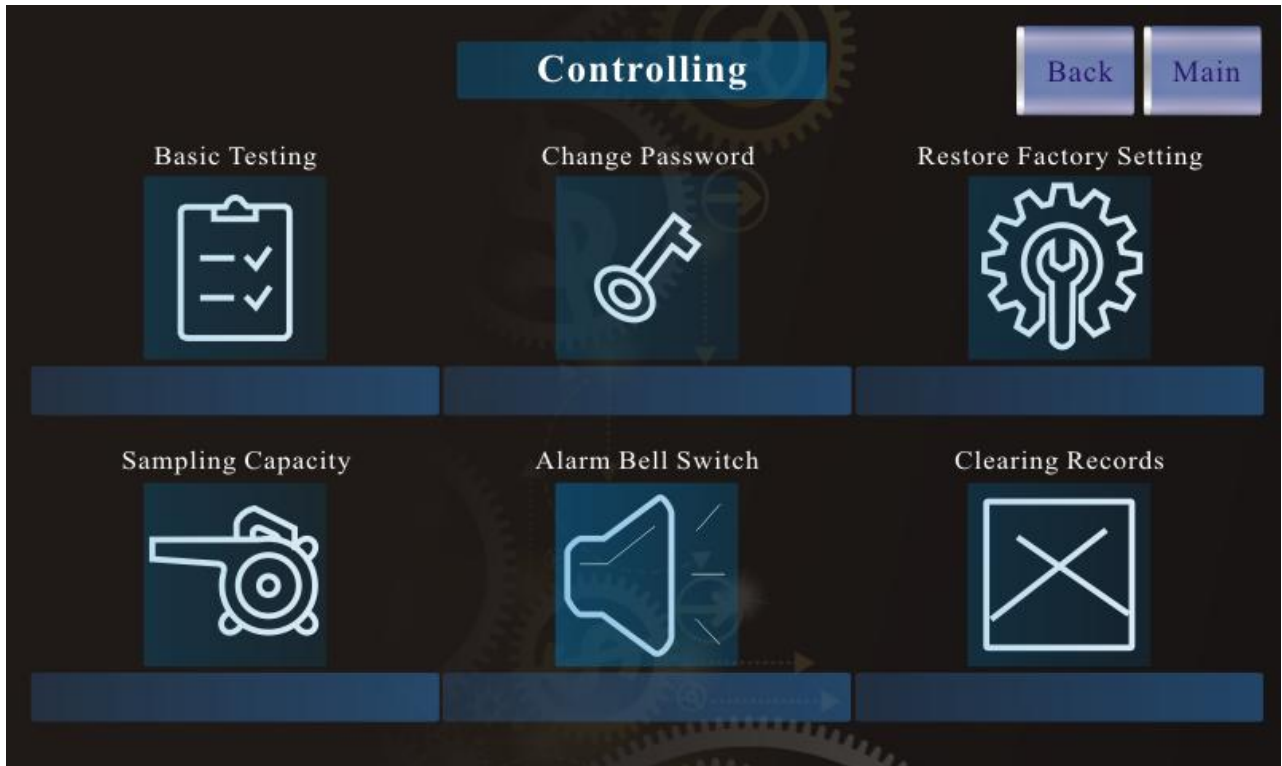

**Basic test:** i.e. application test, which can simulate fault or fire alarm of detector operation.

**Change password:** change the detector operation password

**Restore factory values:** The factory settings of the detector can be restored

**Sampling capacity:** Adjustable suction capacity of the detector's internal fan

**Alarm bell switch:** can turn on/off the buzzer when the detector alarms

**Clear records:** You can clear the historical data records saved by the machine

① "Basic Testing" page:

Click the "Basic Testing" button to enter the application testing page, as follows:

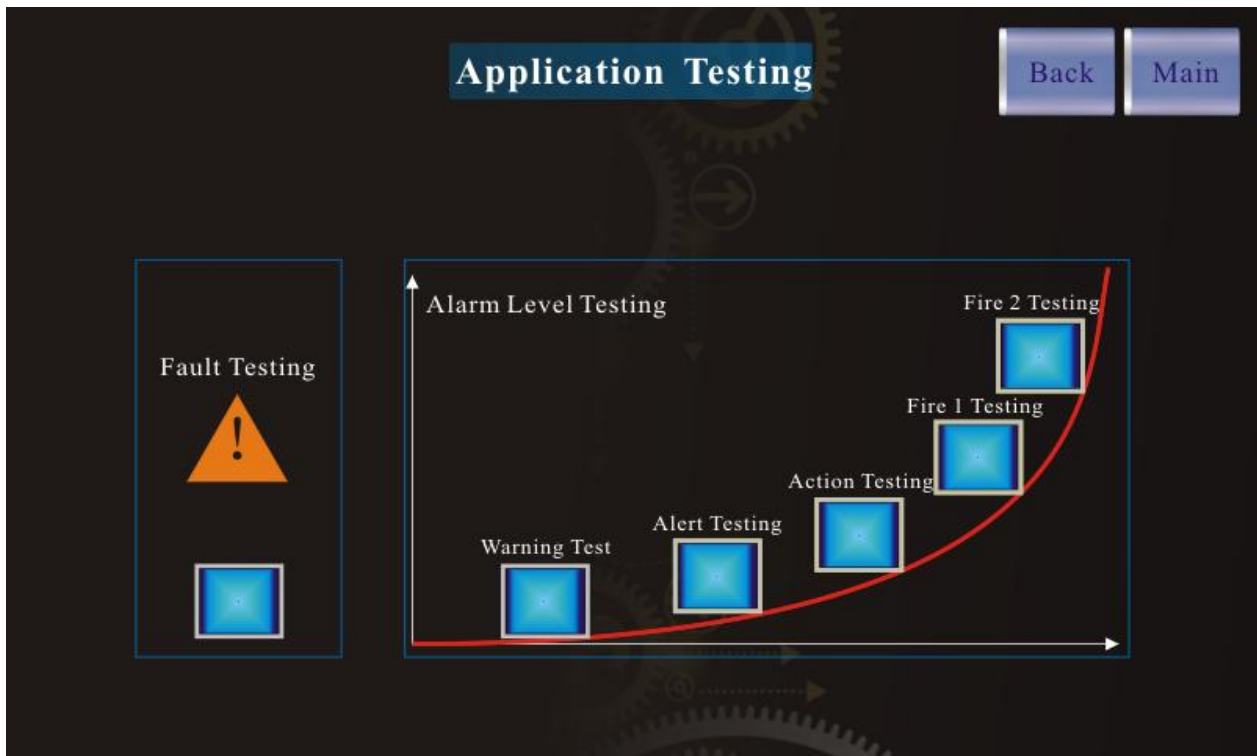

- Fault test:** After selection, the detector enters the fault state, the fault light lights up and the fault relay acts.
- Early warning level test:** After selecting, the detector enters the alarm state of this level, and the corresponding relay will also act.
- Note:** After starting the test function, it can be manually reset or automatically exited after 30 seconds.

② "Screen Display" page

On the main page of the system menu, click the "Screen Display" button and enter the 6-digit password to enter the screen settings page: On this page, you can adjust the screen brightness, calibrate, and adjust the touch screen operation sound. As shown below:

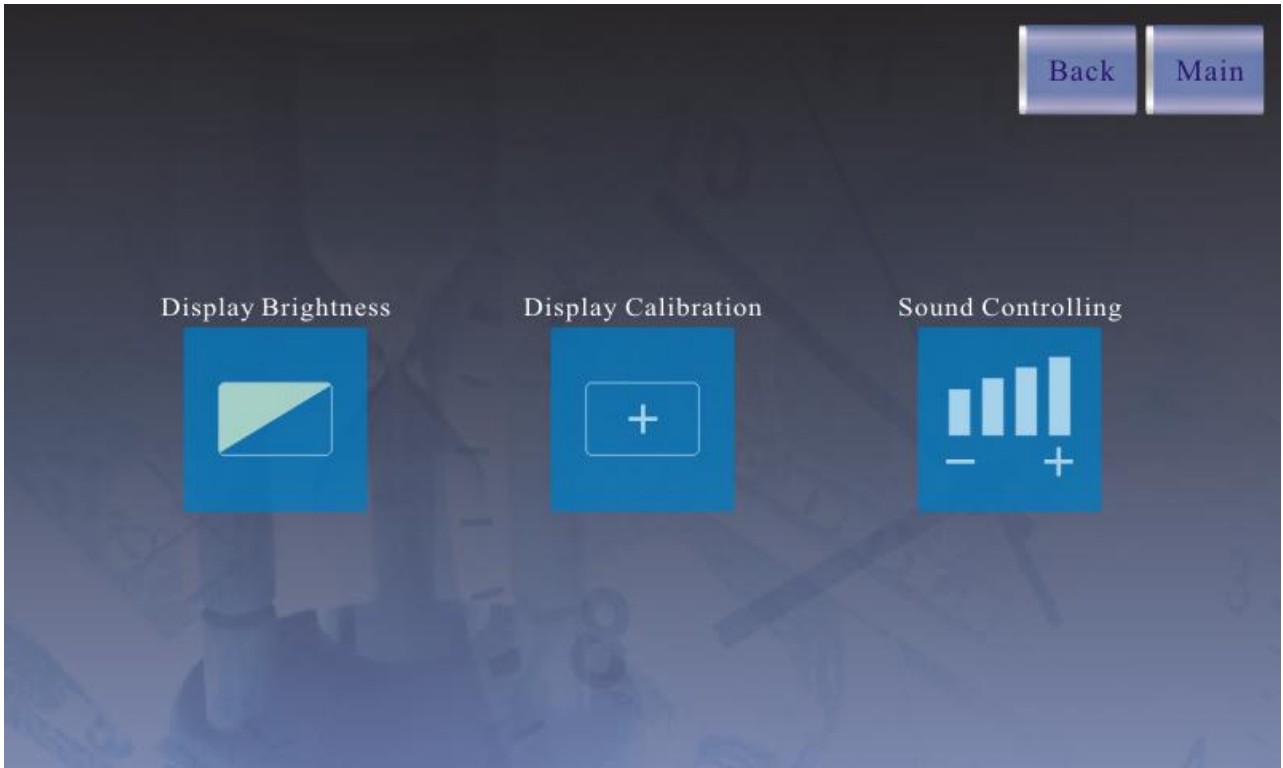

## 5 Installation

### 5.1 Basic size

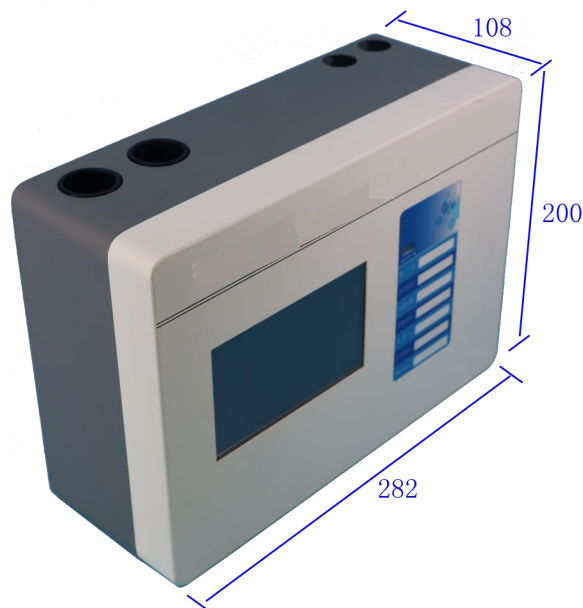

## 5.2 Installation methods

1) Fix the hanging plate of the micro-detector on the wall, as shown in the figure below:



### Notes:

- ① It is recommended that the bottom of the detector be installed 1.5m above the ground;
- ② The hanging board is symmetrical in design and can be installed in both directions;
- ③ In order to facilitate the disassembly of the detector in the future, a gap of no less than 50mm should be reserved in the direction in which the detector slides out;

2) After the installation hanging plate is fixed, install the detector on the hanging plate as shown in the figure:

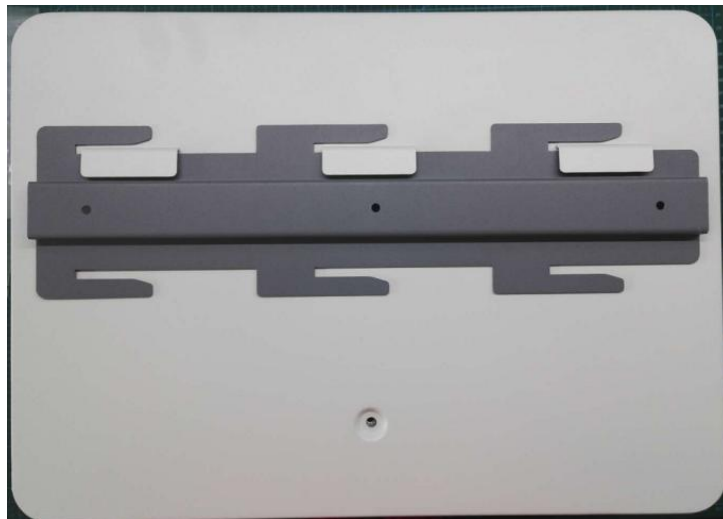

### Notes:

- ① Pay attention to the firmness of the installation after installation to ensure that the detector does not shake or move left and right.

## 5.3 Sampling pipe network installation

The sampling pipe network is used to collect air samples in protected areas, and usually consists of sampling pipes, sampling holes, elbows, straight-throughs, plugs, capillary sampling tubes and micro sampling heads. The quality of the sampling pipe network's ability to collect air has a great impact on the fire detection effect of the detector. Therefore, the design and construction of the sampling pipe network should be combined with the actual project scenario and follow certain principles.

### 5.3.1 Sampling method

According to the different sampling methods of application scenarios, it can be divided into standard sampling, capillary sampling, return air sampling, under-floor sampling and other sampling methods. Its

applicable scenarios are as follows:

**Standard Sampling:** suitable for most scenes without suspended ceilings.

**Capillary sampling:** suitable for scenes or cabinets with suspended ceilings that need to be kept beautiful

**Sampling at the return air outlet:** it is suitable for scenes with a return air system, such as clean workshops and laboratories.

**Underfloor sampling:** suitable for scenarios with raised floors, such as computer rooms.

**Other sampling:** such as cane sampling, cable shaft sampling, and battery rack sampling.

The schematic diagram of the sampling method is as follows:

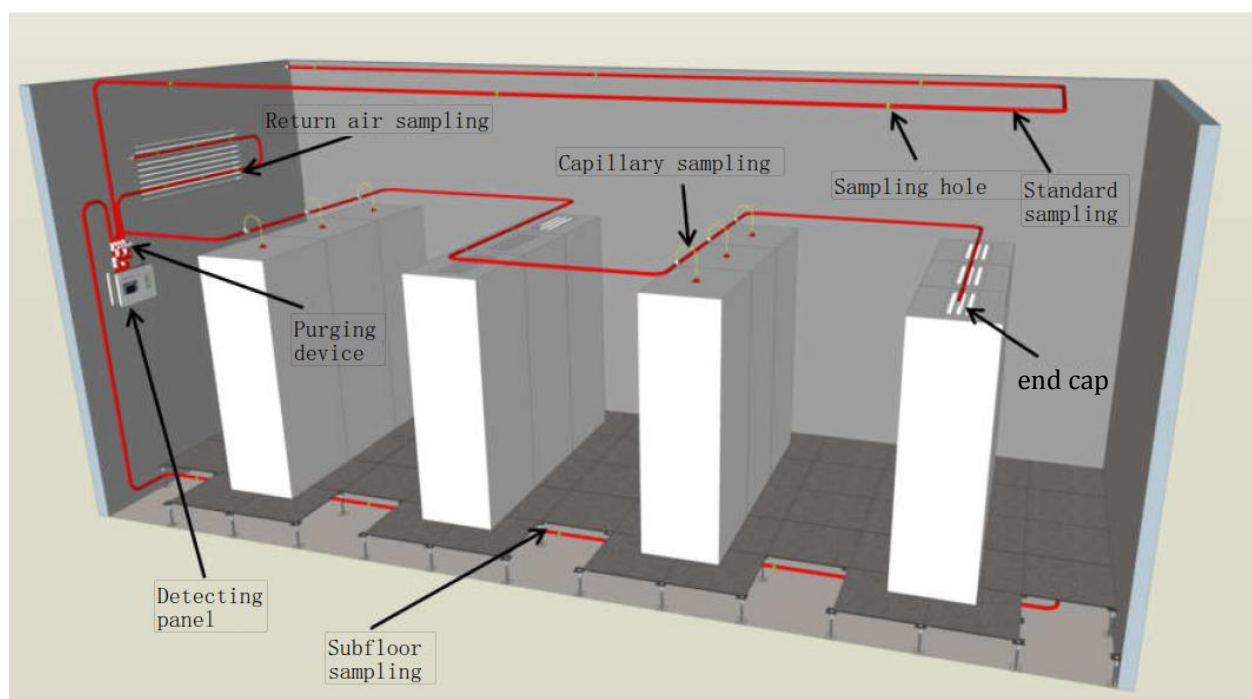

### 5.3.2 General principles

During the installation of the sampling pipe network, the following principles should be followed:

- 1) The sampling pipe is recommended to be made of flame retardant PVC/ABS with an outer diameter of  $\phi 25$ .
- 2) In order to ensure the smoothness of the cut, special pipe cutters should be used for cutting the sampling pipe instead of saw blades.
- 3) It is recommended to use large arc bends or  $45^\circ$  elbows when changing the direction of the pipe network.
- 4) The pipe network interface should be sealed and permanently fixed with UPVC glue or other methods.
- 5) Do not use glue to connect the connection between the pipe and the detection panel, because this will increase the difficulty of later maintenance.
- 6) The sampling hole should be opened vertically to the center of the pipe, and the sampling hole must be smooth and free of dander.
- 7) The opening diameter of the sampling hole is recommended to be 3~5mm (please refer to the drawing or follow the manufacturer's instructions for the specific hole diameter)
- 8) The sampling hole should be pasted with the sampling hole logo.
- 9) An end cap must be installed at the end of each sampling tube, and an end hole of the corresponding size must be opened on the end cap. The diameter of the end hole opening is recommended to be 4~6mm (for

specific hole diameter, please refer to the drawing or follow the manufacturer's instructions).

10) To ensure that the sampling hole will not be blocked or covered by spraying due to other engineering influences, if so, please do protection in advance.

11) Unnecessary turns should be minimized when laying the pipe network. Too many turns will directly affect system performance.

12) Keep the sampling tube from the intubation port of the detection panel as straight as possible, and the straight line distance should not be less than 500mm.

13) To avoid pipe bending, sagging (causing possible system damage), fixation should be done every 1.5 meters or less.

14) When encountering a beam (height ≤ 200mm), the sampling pipe can be laid directly under the beam to avoid walking against the beam, otherwise the performance of the sampling pipe network will be reduced due to too many bends.

15) When crossbeams (height > 600mm) are encountered, sampling should be carried out in a cane-style sampling method. The main sampling tube is arranged under the beam, and extends upwards to the ceiling through the cane at the original sampling hole opening position.

16) When encountering a beam (200mm < height < 600mm), it is necessary to combine the actual height of the protected area to decide whether to use the walking stick sampling method.

## 6 Maintenance

### 6.1 General provisions

After the aspirating smoke detection system is put into use, the following regulations need to be followed:

1) After the completion and acceptance of the system, the position of the sampling pipe network, the number of sampling holes and the openings should not be changed arbitrarily.

2) The system management unit should be equipped with professionals to be responsible for the daily management and maintenance of the system.

3) When the system is officially put into use, the following documents and materials should be available:

- ① As-built drawings of the system and technical information of equipment;
- ② System operating procedures;
- ③ Duty of duty officer, duty record and use chart;
- ④ System maintenance and repair records;

4) The system should maintain continuous normal operation.

### 6.2 Maintenance requirements

The maintenance and testing of the aspirating smoke detection system shall meet the following requirements:

No.	Items	Contents	Frequency	
			Quarter	Year
1	Terminal fire test	Test the smoke response time at the farthest end of each sampling pipe of the detector,	√	



		which should not exceed 120s		
2	Fire alarm performance test	By adding test smoke, the detector should be able to reach a maximum concentration of 2.55 million/CC	√	
3	Strobe sounder signal test	When the detector is in fire alarm or failure state, there should be sound and indicator light display.	√	
4	Reset function test	Check the reset function of the detector	√	
5	Date and time	Check the date and time the detector was run	√	
6	Linkage signal test	Detect the linkage signal situation when the detector alarms	√	
7	Sampling pipe network cleaning	Clean the sampling pipe network and sampling holes with a blower		√

## 7 Faults and Handling Methods

No.	Faults	Cause Analysis	Solution
1	Fan fault	The fan is stuck due to foreign matter or the fan is malfunctioning.	Foreign object stuck: remove the fan and clean the foreign object Fan operation fault: replace fan
2	Cloud chamber communication interrupted	The cloud chamber cable is in poor contact or falling off.	Check the cloud chamber wiring
3	Air leakage	The airflow state of the pipeline becomes larger	Method 1: Power off and restart the detector
4	clogged	The airflow state of the pipeline becomes smaller	Method 2: Turn off airflow monitoring and then turn it back on
5	No response	The calibration status is incorrect or	Recalibrate or replace the cloud

	when lighting a cigarette	the cloud chamber is faulty.	chamber
6	Frequent alarms	There is interference in the environment or the application environment has changed compared with the environment the detector last learned.	<p>a. Environmental interference: Find interference sources according to alarm rules;</p> <p>b. If the application environment changes, recalibration is required:</p> <p><b>Calibration steps:</b></p> <p>① Ensure that the environment is in normal condition and there are no temporary disturbing factors:</p> <p>② Touch screen: Click in the middle → Parameter settings → User-defined settings → Adapt to the environment entrance</p>
7	Fire alarm cannot be reset	When the detector is reset, the real-time concentration value is higher than the lowest level alarm threshold and still meets the alarm conditions.	Compare whether the real-time concentration value on the main page is less than the warning threshold in the upper right corner. If not, you need to wait until it drops below the minimum level threshold before you can reset it
8	system error	Components inside the detector are operating abnormally	Contact the manufacturer's technical personnel for assistance in solving the problem

## AW-AS200-2 Aspirating Smoke Detection System 2 Pipe

Input voltage	18V~30VDC, rated working voltage is 24VDC
Input current	<1A
Maximum power	30W
Sensitive range	0.0002 to 28% (obs/m)
Filter	2 stage filtration
Analysis chamber	cloud chamber
Number of channels	2 channel
Number of zones	No zone devided
Sampling tube length	One pipe is 120m long, and the two pipes are 240m
Sampling tube size	Outer diameter 25mm, inner diameter 21mm
Number of sampling holes	(One tube: 26 pcs; two tubes total: 52 pcs)

## AW-AS200-2 Aspirating Smoke Detection System 2 Pipe

Relay input	3 pairs
Relay output	9 pairs
Relay carrying	30VDC 2Amax/AC125V 0.5Amax
Way of communication	RS485, GPRS, GSM, Zigbee, RF, 4G

Safety design	IEC60950-1
MTBF	200,000 hours
Size	330mm×230mm×110mm (length×height×depth)
Weight	<4kg
Degree of protection	IP40
Installation method	Wall-mount
Cooling method	Natural cooling

---

Protect Area: The protection area of a single hole is 20 m<sup>2</sup>, and the protection area of 50 holes of the whole machine can reach 1000m<sup>2</sup>.